

# VTEC systems

SKF VectoLub

Version	<b>03</b>
Date of issue	<b>March 2018</b>
Publication number	<b>951-130-440</b>
Languages	<b>EN</b>
Country/Countries	<b>...</b>





# Minimal quantity lubrication systems VTEC

English translation of the original installation  
and operation manual

## Imprint

This manual – containing installation, operation and maintenance instructions complies with EC-Machinery Directive 2006/42/EC and is an integral part of the described lubrication system. It must be kept for future use.

This manual – containing installation, operation and maintenance instructions was created in accordance with the valid standards and regulations on documentation.

### © SKF

This documentation is protected by copyright. All rights reserved. The photomechanical reproduction, copying, and distribution of this documentation or parts thereof by means of processes such as data processing, data carriers, and data networks is strictly prohibited without the express permission of SKF.

Subject to editorial or technical modifications.

## Service

For all technical questions, please contact:

SKF France  
Lubrication Product Division  
Bld Charles de Gaulle  
B.P. 239  
37540 St-Cyr-sur-Loire  
FRANCE  
Tel. +33 (0) 247 405 300  
Fax +33 (0) 247 405 353

Or an SKF Service Centre, the addresses of which are given on our website:

[lubrication-france@skf.com](mailto:lubrication-france@skf.com)  
[www.skf.com](http://www.skf.com)

# Contents

<b>Minimal quantity lubrication systems</b>			
<b>VTEC</b> .....	<b>1</b>	2.5 Danger relating to lubricants .....12	
<b>Imprint</b> .....	<b>2</b>	<b>3. Design and function</b> .....	<b>13</b>
<b>Service</b> .....	<b>2</b>	3.1 Versions .....	13
<b>Information concerning the EC</b>		3.2 Construction .....	15
<b>Declaration of Conformity and the EC</b>		3.3 Function .....	17
<b>Declaration of Incorporation</b> .....	<b>4</b>	<b>4. Installation instructions</b> .....	<b>20</b>
<b>General</b> .....	<b>6</b>	4.1 Positioning and installation .....	20
Meaning of symbols and corresponding information .....	6	4.2 Lubricant inlet connection .....	21
<b>1. Safety instructions</b> .....	<b>7</b>	4.3 Air inlet connection .....	21
1.1 Intended use .....	7	4.3 Outlet connection .....	22
1.2 Authorized personnel .....	8	4.4 Electric connection .....	25
1.3 Danger relating to electric current ..	8	<b>5. Transport, delivery and storage</b> ..	<b>27</b>
1.4 Danger relating to system pressure ..	8	5.1 Transport .....	27
1.5 Warranty and liability .....	9	5.2 Delivery .....	27
<b>2. Lubricants</b> .....	<b>10</b>	5.3 Storage .....	27
2.1 General .....	10	<b>6. Activation</b> .....	<b>28</b>
2.2 Selection of lubricants .....	11	6.1 General .....	28
2.3 Approved lubricants .....	11	6.2 Bleeding and commissioning .....	28
2.4 Lubricants and the environment ..	12	6.3 Micropump flow rate adjustment ..	30
		6.4 Pneumatic pulse generator .....	31
		6.5 Carrier air pressure regulator .....	31
		<b>7. Shutdown</b> .....	<b>33</b>
		7.1 Temporary shutdown .....	33
		7.2 Permanent shutdown .....	33
		<b>8. Maintenance</b> .....	<b>34</b>
		<b>9. Failures</b> .....	<b>35</b>
		<b>10. Technical data</b> .....	<b>38</b>
		<b>11. Spare parts and accessories</b> .....	<b>40</b>

# Information concerning the EC Declaration of Conformity and the EC Declaration of Incorporation

For the product(s) designated below:

Minimal quantity lubrication system

Product line:

## VTEC

SKF herewith certifies that it conforms to the pertinent safety requirements set forth in the following Council Directive(s) for the harmonization of the laws of the Member States...

- Machinery Directive 2006/42/EC

### Note:

- 1 This declaration certifies conformity with the aforementioned directive(s), but does not contain any assurance of properties.
- 2 The safety instructions in the owner's manual must be observed.

- 3 The certified product must not be started up until it is confirmed that the equipment, machinery, vehicle or the like in which the product was installed meets the provisions and requirements of the national directives to be applied.
- 4 Operation of the products on non-standard main voltage as well as nonobservance of installation instructions can affect the EMC properties and electrical safety.

SKF further declares that the above mentioned product:

- is meant for integration into a machinery / for connection to other machinery according to the EC-Machinery Directive 2006/42/EC, Appendix II Part B. Starting up the product is not permissible until it is assured that the machinery, vehicle or the like in which the product was installed meets the provisions and requirements of the regulations set forth in the EC Directive 2006/42/EC.

- with reference to the EC Directive 97/23/EC concerning apparatus subjected to pressure, this product must only be used as intended and according to the Owner's manual. Especially observe the following:
  - Products of SKF must not be used in conjunction with fluids, group I (hazardous fluids), according to the definition of article 2 paragraph 2 of the Directive 67/548/EC dtd. 27th June, 1967; and are not approved for application with such fluids.
  - None of the products manufactured by SKF can be used in conjunction with gases, liquefied gases, pressurized gases in solution and fluids with a vapor pressure exceeding normal atmospheric pressure (1013 mbar) by more than 0,5 bar at their maximum permissible temperature.

- When used as intended, the products supplied by SKF do not reach the limit values listed in the Article 3 par. 1, sections 1.1 to 1.3 and par. 2 of the Directive 97/23/EC. Therefore, they do not come under the requirements set forth in annex I of that Directive. They are not labeled with the CE mark with reference to the Directive 97/23/EC. They are classified by SKF to come under Article 3 par. 3 of the Directive.
- The EC Declaration of Conformity and EC-Declaration of Incorporation is part of the product documentation.

# General

## Meaning of symbols and corresponding information

In this manual, the symbols and safety wordings shown on this page are intended to communicate a particular risk to persons, material assets, or the environment.

All safety instructions must be respected by person exposed to these risks. The safety instructions must be communicated to all other persons.

Instructions attached directly to the equipment, such as







- rotational direction arrows
- fluid connection labels, etc.

must be respected and remain perfectly legible.

It is essential to read these instructions thoroughly and to respect the safety instructions given.

Table 1

### Hazard symbols

Symbol	Standard	Meaning
	DIN 4844-2 W000	General hazard
	DIN 4844-2 W008	Voltage
	DIN 4844-2 W026	Hot surface
	DIN 4844-2 W028	Slippery floor
	DIN 4844-2 W027	Risk of hand injury
	DIN 4844-2 W55	Risk of pollution



# 1. Safety instructions

The described product was manufactured in accordance with all generally acknowledged regulations pertaining to technology, occupational safety, and accident prevention. However, dangers that can cause physical injury to persons or damage to other material assets might still occur during the use of the product.

 These instructions must be read and understood by all persons who are involved with the installation, operation, maintenance, and repair of the product. These instructions must be kept close to the equipment for future reference.

Note that these installation instructions is an integral part of the product. It must be handed over to the new operator of the product if the product is sold.

 In addition to the information provided in the installation instructions, all generally applicable regulations on accident prevention and the environment must be observed.

## 1.1 Intended use

The described product is for supplying centralized lubrication systems with lubricant and is intended for use in centralized lubrication systems. Other use or use beyond this purpose is considered unintended.

Products of SKF must not be used in conjunction with substances and mixtures classified as hazardous by the Annex I part 2-5 of the CLP regulation (EC 1272/2008), and identified with hazard pictograms GHS01 - GHS06 and GHS08.

None of the products manufactured by SKF can be used in conjunction with gases, liquefied gases, pressurized gases in solution and fluids with a vapor pressure exceeding normal atmospheric pressure (1013 mbar)

by more than 0.5 bar at their maximum permissible temperature.

Unless otherwise noted, products of SKF must not be used in conjunction with explosive atmospheres according to the ATEX-Directive 2014/34/EU.

 All products from SKF may be used only for their intended purpose as described in this brochure and in any instructions.

## 1.2 Authorized personnel

The products described in the installation instructions may only be installed, operated, maintained, and repaired by qualified experts. Qualified experts are persons who have been trained, instructed, and familiarized with the end product into which the described product is installed.

These persons are considered capable of such tasks due to their education, training, and experience with valid standards, conditions, accident prevention regulations in effect, and installation conditions. They should be able to carry out the required tasks and to recognize – and thus avoid – any dangers that might otherwise occur.

A definition of what constitutes a qualified person and who are unqualified persons are stipulated in DIN VDE 0105 and IEC 364.

## 1.3 Danger relating to electric current

The electrical connection for the described product may only be established by qualified, instructed persons who have been authorized by the operator or owner to carry out this task. If the product is improperly connected, substantial material or personal damage may be the consequence.



### **DANGER!**

Working on products that have not been disconnected from the power supply can cause serious injury or death to persons. Installation, maintenance, and repair work may only be carried out by qualified experts on products that have been disconnected from the power supply. The supply voltage must be turned off before any product components are opened. .

## 1.4 Danger relating to system pressure



### **DANGER!**

Centralized lubrication systems are under pressure when they are being operated. Such systems must therefore be depressurized before starting installation, maintenance, or repair work and before making any changes to the system.

## 1.5 Warranty

The instructions do not contain any information on the warranty. This can be found in the General Conditions of Sales, which are available at: [www.skf.com/lubrication](http://www.skf.com/lubrication).

## 2. Lubricants

### 2.1 General



All SKF products must only be used for their intended purpose and in accordance with the specifications of the installation instructions for the product in question.

The intended use of this product is for the centralized lubrication/lubrication of bearings and wear points with lubricants. All physical limitations of use stipulated in the documentation of the product such as the owner's manual, technical drawings and catalogs must be observed.

More specifically, we call your attention to the fact that substances and mixtures classified as hazardous by the Annex I part 2-5 of the CLP regulation (EC 1272/2008), and identified with hazard pictograms GHS01-GHS06 and GHS08, can only be used to feed the SKF centralized lubrication systems,

transported or distributed by these systems after consultation with SKF and obtaining written permission.

All products manufactured by SKF are not approved for use in conjunction with gases, liquefied gases, pressurized gases in solution and fluids with a vapor pressure exceeding normal atmospheric pressure (1013 mbar) by more than 0,5 bar at their maximum permissible temperature.

Should there be a need to use the product to convey media other than lubricants or hazardous substances, this must be discussed with SKF first and the company must give express written permission.

In the opinion of SKF, lubricants constitute a design element that must be considered when selecting components and designing centralized lubrication systems. The lubrication properties of the lubricants in question must be considered.

## 2.2 Selection of lubricants



You must observe the machinery manufacturer's information on the lubricants to be used in the machinery.



### **DANGER!**

The manufacturer of the bearing or machinery to be lubricated will specify the lubricant requirements for each point to be lubricated. You must make sure that the required quantity of lubricant is provided to the relevant lubricating point. If a lubricating point is insufficiently lubricated, the bearing may become damaged or jammed.

While the machinery/bearing manufacturer usually specifies lubricants, it is the owner/operator (or maintenance person) who must finally select the appropriate lubricant, with the help of the lubricant supplier. When selecting a lubricant, the type of bearing/wear point, the stresses and strains to be expected during operation, and anticipated ambient conditions must be taken into account. All financial/economic aspects must also be considered.



If required, SKF can help customers to select suitable components for the conveyance of the selected lubricant and to plan and design their centralized lubrication system.

If you have further questions, you can contact SKF.

We can test lubricants in our own laboratory to establish their suitability for convey-

ance (e.g. 'oil separation' behavior) in centralized lubrication systems.

You can request an overview of lubricant tests offered by SKF from our Service Center.

## 2.3 Approved lubricants



### **DANGER!**

Only lubricants that have been approved by SKF for use with the product may be used. Unsuitable lubricants can cause product malfunctions and damage to property.

**DANGER!**

Different lubricants must not be mixed together. Doing so can cause damage and require extensive cleaning of the products/centralized lubrication system. To prevent confusion, we recommend that you attach information indicating the lubricant to be used on the lubricant reservoir.

The described product can be operated with lubricants that comply with the specifications in the technical data.

Note that some lubricants may have properties that lie within the permitted limit values and yet not be suitable for use in centralized lubrication systems for other reasons. For example, some synthetic lubricants are not compatible with elastomers.

## 2.4 Lubricants and the environment

**DANGER!**

Lubricants can contaminate the ground and watercourses. Lubricants must be used and disposed of in compliance with the rules. Instructions and local regulations must be observed when handling lubricants.

Note that lubricants are harmful to the environment and flammable; their transportation, storage, and processing are subject to special precautionary measures. For specifications on transportation, storage, processing, and dangers to the use and the environment for the lubricant, refer to the material safety data sheet provided by or available from the lubricant manufacturer. You can ask the manufacturer of the lubricant for the material safety data sheet.

## 2.5 Danger relating to lubricants

**DANGER!**

Centralized lubrication systems must be absolutely leak-free. Leaking centralized lubrication systems can cause a slip hazard. When performing installation, maintenance, and repairs test the centralized lubrication system for leaks. Leaky parts of the centralized lubrication system or components of the lubrication equipment have to be sealed immediately.

Leaking centralized lubrication systems or components of the lubrication equipment are a source of danger in relation to slip hazard and the risk of injury. These dangers can cause physical injury to persons or damage to other material assets.

Refer to safety precautions in the lubricant manufacturer's material safety data sheet.

Lubricants are hazardous substance. It is essential to respect any safety instructions given in the lubricant safety data sheet. You can ask the manufacturer of the lubricant for the material safety data sheet.

## 3. Design and function

### 3.1 Versions

The VTEC system is a modular system, which can comprise up to 8 modules. These modules corresponds to bases with various functions (→ **page 19**).

Every model of a VTEC unit has a codification, which the user has indicated when ordering.

In order to easy identify the current VTEC unit and to know its different functions, we suggest you to write down the unit codification given when the order has been placed. The table hereafter will help you to identify every module of the VTEC unit and the different functions.

The codification system is the same for every module. A module has a three-characters reference. The first module is always the one with the lubricant and compressed air inlets.

The last three numbers of the codification correspond to the voltage key of the VTEC unit:

- + 428 : 230 V, 50/60 Hz
- + 429 : 115 V, 50/60 Hz
- + 924 : 24 V DC



If a minimal quantity lubrication unit is not listed in table 2, please refer to the delivered technical sheet to know the specific technical data of the minimal quantity lubrication unit.

## VTEC codification

VTEC - ... - ... - ... - ... - ... - ... - ... - ... + ...

**First character**

A	base alone
B	base with pneumatic pulse generator
C	base with air solenoid valve
D	base with pneumatic pulse generator + air solenoid valve
E	base + GS304P alone
F	base + GS304P with pneumatic pulse generator
G	base + GS304P with air solenoid valve
H	base + GS304P with pneumatic pulse generator + air solenoid valve
I	base with general air solenoid valve
J	base alone (directly controlled by base 'I')
K	base + GS304P alone (directly controlled by base 'I')

**Second character**

A	micropump, metering ring, max. flow rate 30 mm <sup>3</sup> /stroke
B	micropump, thumb wheel, max. flow rate 30 mm <sup>3</sup> /stroke
C	micropump, metering ring, stainless steel, max. flow rate 30mm <sup>3</sup> /stroke
D	micropump, thumb wheel, stainless steel, max. flow rate 30mm <sup>3</sup> /stroke
E	micropump, metering ring, max. flow rate 90mm <sup>3</sup> /stroke
F	micropump, thumb wheel, max. flow rate 90mm <sup>3</sup> /stroke
G	micropump, metering ring, stainless steel, max. flow rate 90mm <sup>3</sup> /stroke
H	micropump, thumb wheel, stainless steel, max. flow rate 90mm <sup>3</sup> /stroke
Z	no micropump (only with base 'I' – general air solenoid valve)

**Third character**

Z	no air monitoring
M	air flow monitoring with manometer
P	air flow monitoring with pressure switch



## 3.2 Construction

The VTEC unit is a modular lubrication system comprising up to 8 different modules. The unit is mounted on a standard fixing rail.

Figure 1 shows one model of a VTEC unit with 7 different modules. Every module has a base with different functions.

This is a front side view with the compressed air and lubricant inlets on the left side.

The VTEC unit has one lubricant inlet with quick-release connector, and two compressed air inlet with quick-release connector.

But only one air inlet port is used, the other being closed with a screw plug. The lower air inlet port is used when the first module has a “I” base (with a general air solenoid valve). The upper inlet port is used with every other bases.

Except the “I” base, with the general air solenoid valve, all other bases work in the same way.

Every module has on the top an outlet port for coaxial hose air and lubricant with two quick-release connectors. The quick-release connector for the capillary tube (lubricant) is located beneath the quick-release connector for the outer tube (air). The user

can set the carrier air pressure with a pressure regulator. The air flow can be monitored either with a manometer or with a pressure switch.

A pneumatic micropump is mounted under every module. The user can adjust the flow rate of the pump with metering rings or with a thumb wheel.

A module can have up to three different additional equipments on the front side:

- a pneumatic pulse generator to adjust the delivery frequency of the micropump
- an air solenoid valve to control the air inlet for the pneumatic micropump.
- a flow sensor, type GS304P, to monitor the oil flow of the module.

Every module can have one, two or three of the equipment, and even none. According to the equipment a module is “slave” or “master”.

Fig. 1

## Overview of a VTEC unit

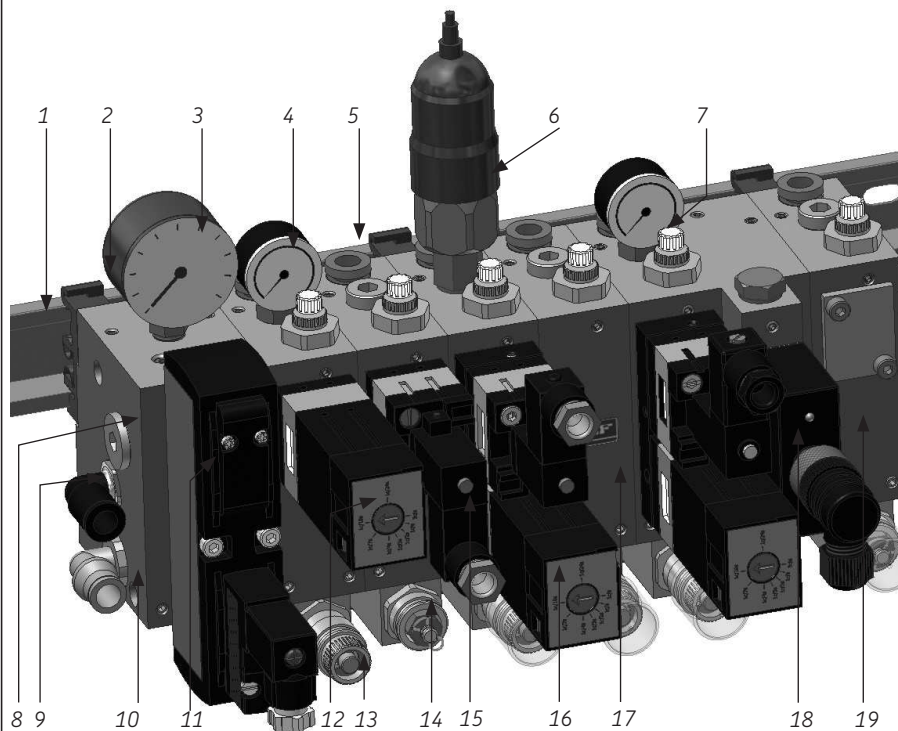

- 1 standard fixing rail
- 2 fixing clips
- 3 manometer, general air monitoring
- 4 manometer, carrier air monitoring
- 5 coaxial outlet port (air and oil)
- 6 pressure switch, carrier air monitoring
- 7 carrier air pressure regulator
- 8 air inlet port
- 9 air inlet port (module with a general air solenoid valve)
- 10 Lubricant inlet
- 11 General air solenoid valve
- 12 Pneumatic pulse generator
- 13 Pneumatic micropump, setting with thumb wheel
- 14 Pneumatic micropump, setting with metering ring
- 15 Micropump control solenoid valve
- 16 Pneumatic pulse generator and an air solenoid valve (control of micropump) put together with a connection plate
- 17 Base without additional equipment (A)
- 18 Oil flow sensor GS304P
- 19 Base without additional equipment (J)

Model: VTEC-IZM-BBM-CAZ-DBP-ABZ-HBM-JAZ+ 924

### 3.3 Function

When the VTEC unit is switched on, it is supplied with compressed air (5 to 8 bar) and with lubricant (0,1 to 0,5 bar).

The lubricant flows through the different bases to the volumetric pneumatic micro-pump. The delivery frequency of the micro-pump ( max. 3 stroke/s) is independently adjusted with either a pneumatic pulse generator or a solenoid valve, which is controlled via a control unit. The flow rate of the micropump can be adjusted with metering rings or with a thumb wheel.

The micropump delivers a metered quantity of lubricant, which goes through inner channel of the base to the coaxial outlet port. The lubricant flow can be monitored at the micropump outlet with a flow sensor type GS304P.

The compressed air also flows through the different bases and is divided in two ways in each of them. Some compressed air is supplied to the micropump to actuate it. The other part of the compressed air (called carrier air) is supplied to the coaxial outlet port and goes through the outer tube of the hose. The carrier air pressure of every base can be adjusted with a pressure regulator. This

pressure can be also monitored by means of a manometer or a pressure switch.

The low-pressure carrier air and lubricant are simultaneously transported via the coaxial hose to the nozzle. The carrier air is swirled in the nozzle. As a result, the metered quantity of lubricant is broken down into microdroplets, which are transported by the carrier air to the friction point without causing any mist. The microdroplet size (200/600  $\mu\text{m}$ ) ensures a perfect lubricant coating without atomization.

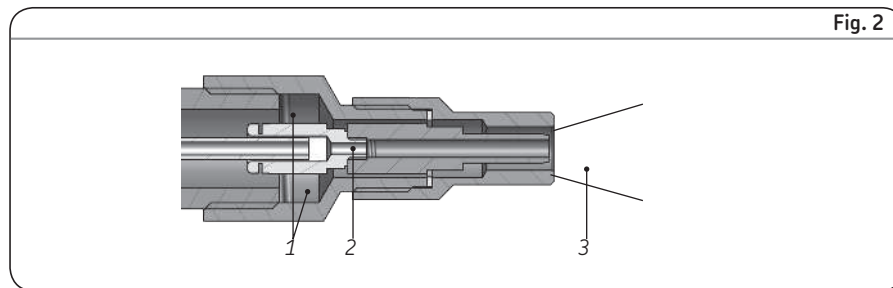

**Projection nozzle for VTEC**

- 1 Carrier air
- 2 Lubricant
- 3 Turbulence zone

### 3.3.1 Master module and slave module



When a VTEC unit is seen from the front side (as on figure 1), the first module is on the left side with lubricant and air inlets – module position order from left to right.

When a module doesn't have one (or several) of the control equipments (general air solenoid valve, air solenoid valve or pneumatic pulse generator) it will depend for this function on the module mounted upstream, which has the equipment(s). The upstream module with the equipment is called 'master module' and the other 'slave module'.

Table 3 shows the different modules with their main functions according to their equipment.

Bases with their main equipment and functions.

- Base alone **(A)** This base has no additional function. It is always used as slave of the master base positioned upstream.
- Base with a pneumatic pulse generator **(B)** The pulse generator adjusts the working frequency of the micropump. A base with an air solenoid valve, positioned upstream, controls the air inlet, which actuates the micropump.
- Base with an air solenoid valve **(C)** The air solenoid valve controls the micropump. The micropump working frequency is adjusted by the solenoid valve, which is controlled by a control unit.
- Base with a pneumatic pulse generator and an air solenoid valve **(D)** The air solenoid valve controls the micropump and the pulse generator adjusts the working frequency of the micropump.
- Base with only a flow sensor GS304P **(E)** The flow sensor GS304P monitors the lubricant outflow of the micropump. This base has no other additional function. It is always used as slave of the master base positioned upstream.
- Base with a flow sensor GS304P and a pneumatic pulse generator **(F)** The flow sensor GS304P monitors the lubricant outflow of the micropump. The pulse generator adjusts the working frequency of the micropump. A base with an air solenoid valve, positioned upstream, controls the air inlet, which actuates the micropump.
- Base with a flow sensor GS304P and an air solenoid valve **(G)** The flow sensor GS304P monitors the lubricant outflow of the micropump. The air solenoid valve controls the micropump. The micropump working frequency is adjusted by the solenoid valve, which is controlled by a control unit.
- Base with a flow sensor GS304P, a pneumatic pulse generator and an air solenoid valve **(H)** The flow sensor GS304P monitors the lubricant outflow of the micropump. The air solenoid valve controls the micropump and the pulse generator adjusts the working frequency of the micropump.
- Base with a general air solenoid valve **(I)** The general air solenoid valve controls the air inlet for the pneumatic micropumps as well as the carrier air inlet. This base is always master of the other bases which are placed downstream.
- Base alone **(J)** This base has no additional function. This base has no additional function. It is always slave of a base with a solenoid valve for general air **(I)**.
- Base with only a flow sensor GS304P **(K)** The flow sensor GS304P monitors the lubricant outflow of the micropump. This base has no other additional function. This base has no additional function. It is always slave of a base with a solenoid valve for general air **(I)**.

## 4. Installation instructions

The minimal quantity lubrication system described in the mounting instructions may only be installed, operated, maintained, and repaired by qualified experts. Qualified personnel are persons who have been trained, instructed, and familiarized by the user of the end product into which the system is installed. These persons are considered capable of such tasks due to their education, training, and experience with valid standards, conditions, accident prevention regulations in effect, and installation conditions. They should be able to carry out the required tasks and to recognize – and thus avoid – any dangers that might otherwise occur.

A definition of what constitutes a qualified person and who are unqualified persons are stipulated in DIN VDE 0105 and IEC 364.

Before installing/positioning the minimal quantity lubrication system, remove the packaging material and any transportation safety devices such as sealing plugs. Keep the packaging material until any and all problems have been clarified.

Country-specific accident prevention regulations and the operating and maintenance instructions for the operator must be ob-



### CAUTION!

The minimal quantity lubrication system must not be tipped over or thrown.

served when carrying out all installation work on machines.

## 4.1 Positioning and installation

### 4.1 Positioning

The system must be mounted in a way that protects it from humidity and vibrations. It should also be easily accessible so that all other installation work can be carried out without hindrance. Ensure that there is sufficient circulating air to prevent the system from overheating. For information on the maximum admissible ambient temperature, see the technical data section.

Before installing a VTEC unit, remove the packaging material as well as any transport safety devices (e.g. sealing plug in the open outlet).

The VTEC unit can be delivered either in a protective housing (option) or simply mounted on a standard fixing rail by means of the fixing clips on the backside.

### 4.1.2 Connection

The lubricant and compressed air inlet lines are connected to a VTEC unit on the first module (left side when unit seen from the front side as on Fig. 1), which has two quick-release connectors.



### CAUTION!

The minimal quantity lubrication system must be securely fixed to its support to avoid accidental tipping. If the system falls it could be damaged or cause damages and can also injure an operator or another person.

## 4.2 Lubricant inlet connection

Lubricant is supplied to the VTEC unit via a  $\varnothing 8$  tube and a quick release coupling (1).

- Insert the hose into the quick-release coupling
- Pull carefully on the hose to check it is correctly held by the coupling.

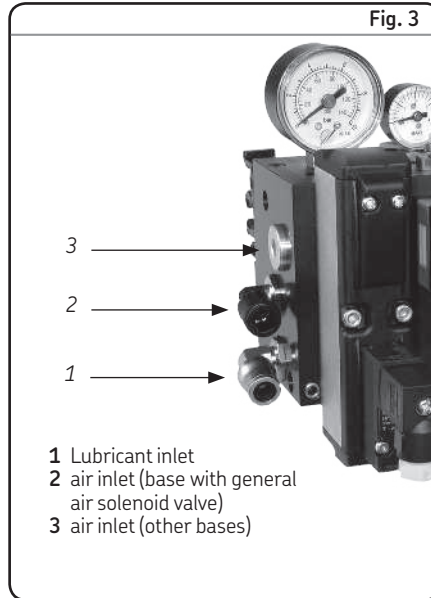

## 4.3 Air inlet connection



For the good function of a VTEC unit, the air pressure inlet shall not exceed 8 bar.

The compressed air line must be connected to the system in such a way that once mounted, no force is applied to the pump (no pressure on the connection).

It is important to use pipes that are sufficiently long so that maintenance and repairs can be carried out at a later time without hindrance.

Compressed air is supplied to the VTEC unit via a  $\varnothing 8$  tube and a quick release coupling (2).



According to the base of the first module (with a general air solenoid valve - as shown in Fig. 3 - or not), the quick-release connector for compressed air is not at the same place. The unused air inlet port is closed with a screw plug.

- Insert the hose into the quick-release coupling
- Pull carefully on the hose to check it is correctly held by the coupling.



## DANGER!

Before connecting the pump to the compressed air feed ensure that the main air valve is closed.

The compressed air quality must comply with purity class 5 defined by DIN ISO 8573-1:

- Maximum particle size: 5  $\mu\text{m}$
- Maximum particle density: 10  $\text{mg}/\text{m}^3$
- Dew point: 7  $^{\circ}\text{C}$
- Maximum water content : 7.800  $\text{mg}/\text{m}^3$
- Maximum residual oil content: 25  $\text{mg}/\text{m}^3$

## 4.3 Outlet connection

### 4.3.1 Connection coaxial line / outlet port



The coaxial line may be only connected by authorized and trained specialists.



The coaxial line has first to be connected to the outlet port of the VTEC, and then to the nozzle.



It is recommended to identify an outlet in accordance with the nozzle it supplies, e.g. with tubes of different colors, with identification rings or others.

The coaxial line (from 1 to 5 m\*) is connected to the VTEC outlet port by means of quick-release connectors.

\*) For greater line length, please contact the SKF service center.

Every outlet port has two quick-release connectors ( $\rightarrow$  fig. 4).

The lower connector holds the capillary tube of the line (lubricant). The upper connector (orange collar) holds the outer tube of the coaxial line (air).

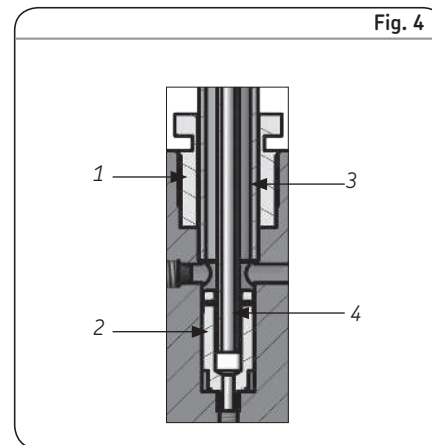

### Cross-section view of the outlet port

1 Upper quick-release connector

2 Lower quick-release connector

3 Outer tube of the coaxial line

4 Capillary tube of the coaxial line



- Pull out (ca. 10 cm) the capillary tube from the coaxial line
- Insert the capillary tube into the outlet port and fit it to the lower quick-release connector (→ **A fig. 5**).
- Pull slightly the capillary tube to check it is correctly held.
- Insert the outer tube into the outlet port and fit it to the upper quick-release connector (→ **B fig. 5**).
- Pull slightly the outer tube to check it is correctly held.

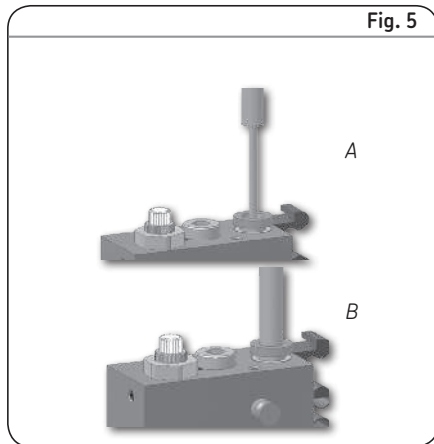

Fig. 5

#### 4.3.2 Connection coaxial line / projection block

**!** The coaxial line may be only connected by authorized and trained specialists.

**!** The coaxial line can be connected to the projection block only if it is already connected to the outlet port of the VTEC.

**!** When mounting or dismounting, never twist, bend or crush the coaxial tube.

The length of the coaxial line between the outlet port of the module and the nozzle has to be between 1 and 5 m. For greater length, please contact the SKF service center.

*Step 1* (→ fig. 6).

- Unscrew and remove the nozzle (1) from the end tube (rigid or articulated) (3).

- Slip the capillary (7) into the quick connector (6) of the fixing block (5) until it is coming out of the end tube (3).

*Step 2*

- Insert the outer tube (8) of the coaxial hose (9) into the quick connector (6) of the fixing block (5).
- Pull carefully the hose (9) to check that the outer tube (8) is correctly fixed.
- Stretch the capillary tube (7) from the end tube (3) and cut it (15 to 25 mm out of the tube). Maintain the capillary tube otherwise it will retract.

*Step 3*

- Insert the capillary tube (7) into the quick connector (10) of the nozzle (1).
- Pull carefully the capillary tube (7) to check it is correctly fixed.

*Step 4*

- Screw in and tighten the nozzle (1) onto the end tube (3).

**Fig. 6**

**Connection coaxial line/nozzle**

- 1** Nozzle
- 2** Union end tube - nozzle
- 3** End tube
- 4** Union fixing block - end tube
- 5** Fixing block
- 6** Quick-release connector
- 7** Capillary tube of the coaxial line
- 8** Outer tube of the coaxial line
- 9** Coaxial line
- 10** Quick-release connector

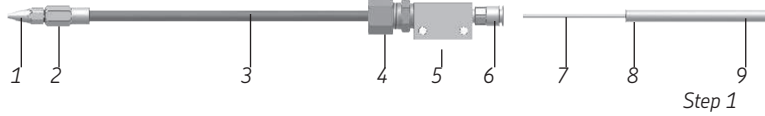

*Step 1*



*Step 2*



*Step 3*



*Step 4*

## 4.4 Electric connection



### **DANGER!**

Only qualified personnel with specific training and authorization from the user may hook up the electrical connections on the MQL system. The connection conditions and the local regulations (e.g. DIN, VDE, NF) must be scrupulously respected. If systems are improperly connected, substantial material or personal damage may be the consequence.



### **DANGER!**

The supply voltage on site must agree with the information on the codification of the VTEC unit. Check the fusing of the circuit. Use only the original fuse with the required ampere value. If other fuses are used, damage to property or personal injury may be the consequence.

### 4.4.1 Solenoid valve

Wiring depends on the operating voltage of the solenoid valve. The voltage key at the end of the VTEC number indicates the operating voltage.

Fig. 7

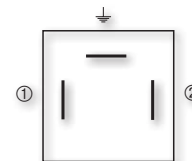

### **Electrical connection**

VTEC unit with the following voltage keys:

- **+428** (230 V CA, 50/60 Hz) or
- **+429** (115 V CA, 50/60 Hz)

Fig. 8

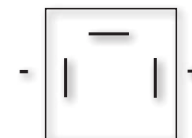

### **Electrical connection**

VTEC unit with the following voltage keys:

- **+924** (24 V DC)

#### 4.4.2 Lubricant flow sensor GS304P

Figure 9 shows the wiring diagram and the assignment of the cable leads or round connector pins for the flow sensor. For any other information about the electric connection, please refer to the technical data.

#### 4.4.3 Pressure switch

Pressure switches are 2 leads on/off switches (operating voltage 24 V DC)



The lubricant flow sensor only works with direct current (voltage key +924)

Fig. 9

##### GS304P wiring

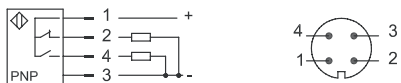

- Pin 1 (BN - brown): + 24 V
- Pin 2 (WH - white): PNP/NC – opens in event of flow
- Pin 3 (BU – blue): 0 V
- Pin 4 (BK – black): PNP/NO – closes in event of flow

## 5. Transport, delivery and storage

### 5.1 Transport

SKF products are packaged in accordance with the regulations of the recipient country and in accordance with DIN ISO 9001. Our products must be transported with care. Products must be protected against mechanical influences such as impacts. Transport packaging must be labeled with the information 'Do not drop!'.



The product must not be tipped up or dropped.

There are no restrictions relating to land, air, or sea transportation.

### 5.2 Delivery

Following receipt of the shipment, the product or products must be checked for damage and the shipping documents should be used to make sure that the delivery is complete. Keep the packaging material until any and all problems have been clarified.

### 5.3 Storage

The following conditions apply to the storage of SKF products.

#### 5.3.1 Storage of lubrication units

- Ambient conditions: dry, dust-free environment; storage in well-ventilated, dry area
- Storage time: 24 months max.
- Permitted air humidity: < 65%
- Warehouse temperature: 10 – 40 °C
- Light: direct sunlight/UV radiation must be avoided; nearby sources of heat must be screened

#### 5.3.2 Storage of electronic and electrical devices

- Ambient conditions: dry, dust-free environment; storage in well-ventilated, dry area

- Storage time: 24 months max.
- Permitted air humidity: < 65%
- Warehouse temperature: 10 – 40 °C
- Light: direct sunlight/UV radiation must be avoided; nearby sources of heat must be screened

#### 5.3.3 Storage – general information

- Ensure that no dust gets into stored products by wrapping them in plastic film
- Store products on racks or pallets to protect them from damp floors
- Before placing products into storage, protect uncoated metal surfaces – and drive parts and mount surfaces in particular – from corrosion using long-term corrosion protection.

## 6. Activation

### 6.1 General

The minimal quantity lubrication system described here runs automatically. However it is recommended that you regularly visually check the transport of lubricant in the lines and the lubricant projection at the nozzles.

 You must observe the machinery manufacturer's information on the lubricants to be used in the machinery.

 Lubricant should not be sprayed at a person nor on a hot/incandescent body.

 **CAUTION!** Only use a clean lubricant. Soiled lubricants can cause major defects in the system.

 **CAUTION!** Different lubricants must not be mixed together. Doing so can cause damage and require extensive cleaning of the VTEC unit. To prevent any risk of error, it is recommended to clearly identify the lubricant used on the reservoir.

 **CAUTION!** Depending on the nature of the lubricant used, the user should wear protective equipment such as glasses, a mask and gloves. For further information please consult the technical file and the safety data sheet for the lubricant used.

### 6.2 Bleeding and commissioning

Before starting the VTEC unit, check that all outer connections (reservoir, air supply, lube lines to the nozzles...) have been well mounted and tightened.

#### 6.2.1 Startup

- Bleed the VTEC unit before starting.
- Set the micropump metered volume according to the needs.

 To ensure the good function of the micropumps with thumb wheel, the minimal flow rate has to be above 7 mm<sup>3</sup>/stroke.

- Set the micropump working frequency according to the needs.

When the VTEC unit is in operation, you can adjust the carrier air pressure at any time

with the air pressure regulator. With a higher flow rate, you get a finer atomization of the lubricant, and the lubrication is then more homogeneous all over the surface to be lubricated.

- Feed the unit with lubricant until it comes out without air bubbles.
- Put back and tighten the screw plug.

#### *Bleeding the micropump*

- Set all the micropumps to their maximal flow rate.
- Let the micropumps operate until lubricant is coming out from the nozzles.



If the carrier air pressure is too high, there will be a problem with the atomization. The lubricant particles would be too fine and may keep suspended in the air.

### **6.2.2 System bleeding**

To correctly bleed a VTEC unit, first bleed the unit itself and then bleed the micropumps.

#### **Bleeding the unit**

- Unscrew and remove the screw plug, which is closing the lubricant duct of the last module of the VTEC unit.

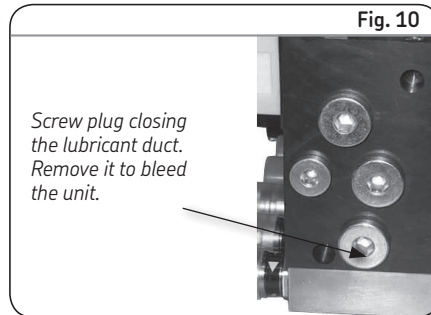

### **6.2.3 Neutralizing the micropump delivery**

A nozzle can be switched out at any time without disturbing the good function of the other nozzles fed by the VTEC unit.

#### Procedure

- Switch off the carrier air flow. Therefore turn the air pressure regulator fully to the right (air flow reduced to 0).
- Switch off the lubricant flow. Therefore adjust the micropump flow rate to 0 (with the '0' metering ring, or turn the thumb wheel fully to the left).

## 6.3 Micropump flow rate adjustment

There are two different possibilities to adjust the flow rate of the micropump. It can be adjusted by the use of a thumb wheel or metering rings.

 The VTEC unit has to be disconnected from power before any adjustment.

 Before adjusting the micropump flow rate, the VTEC unit has to be depressurized.

 Table 3 on page 32 helps you for an optimal adjustment of the micropump flow rate. It shows the flow rate (mm<sup>3</sup> per minute) according to the metered volume adjustment and the working frequency of the micropump.

### 6.3.1 Adjustment with thumb wheel

- Remove the protection cap from the thumb wheel.
- Turn the thumb wheel to the left to reduce and to the right to increase the flow rate.
- A complete turn of the thumb wheel corresponds to a flow rate of 5 (small flow) or 15 mm<sup>3</sup> / stroke (large flow).
- Put back the protection cap on the thumb wheel.

 When the VTEC unit is delivered, the delivery rate of the micropump is set at the maximum ( 30 or 90 mm<sup>3</sup> / stroke according to the model).

 We suggest to start the setting from the maximal flow rate (thumb wheel fully turned to the right)

### 6.3.2 Adjustment with metering ring

- Remove the protection cap from the thumb wheel.
- Remove the clip from the groove.

- Remove the metering ring (when one) and put the new metering ring. Figure of delivered volume is embossed on every metering ring.
- Put back the clip on the groove.
- Put back the protection cap on the thumb wheel.

 When the VTEC unit is delivered, the micropumps have a set of different metering rings (0, 3, 5, 10, 15 and 20 mm<sup>3</sup> or 0, 30, 45 and 60 mm<sup>3</sup>).

 When the micropump has no metering ring, it is set at the maximal flow rate (30 or 90 mm<sup>3</sup>/stroke according to the model).



### 6.3.3 Neutralizing the micropump delivery

The micropump lubricant outflow can be neutralized at any time.

For the micropump with adjustment of the flow rate with thumb wheel: fully turn the thumb wheel to the left.

For the micropump with adjustment of the flow rate with metering rings: replace the current metering ring (when there is one) by the '0' metering ring.



The '0' metering ring is very important in order to neutralize the micropump lubricant outflow. Do not lose it.

## 6.4 Pneumatic pulse generator

The pulse generator adjusts the working fre-

quency of all micropumps. The frequency is indicated on the pulse generator in pulses (piston stroke) per second. The values on the generator are indicative and may vary according to the air inlet pressure.

- Use a slotted screwdriver to adjust the pneumatic pulse generator.

## 6.5 Carrier air pressure regulator

Every module has on the top a carrier air pressure regulator. According to the needs of the nozzle corresponding to this outlet, it is possible to increase or reduce this carrier air pressure.

- Turn the regulator to the left (front view of the module as in page 9) to build up the pressure and to the right to reduce it.
- Loosen the counter nut to block the flow regulator in order to prevent any accidental modification of the pressure.



When the pressure regulator is completely turned to the right, there is no more carrier air flow.

Fig. 11

### Pulse generator setting scale

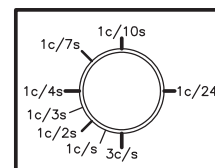
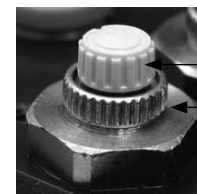

Fig. 12



### Pressure regulator

- 1 Carrier air pressure regulator
- 2 Locking counter nut

Table 4

The Vectometer shows different flow rate (in mm<sup>3</sup> per minute) according to the lubricant flow rate and the working frequency of the micropump.

Setting [mm <sup>3</sup> /stroke]	Micropump working frequency [stroke/minute]										
	2,5	6	8,5	10	20	30	60	90	120	150	180
<b>3</b>	7,5	18	25,5	30	60	90	180	270	360	450	540
<b>5</b>	12,5	30	42,5	50	100	150	300	450	600	750	900
<b>10</b>	25	60	85	100	200	300	600	900	1 200	1 500	1 800
<b>15</b>	37,5	90	127,5	150	300	450	900	1 350	1 800	2 250	2 700
<b>20</b>	50	120	170	200	400	600	1 200	1 800	2 400	3 000	3 600
<b>25</b>	62,5	150	212,5	250	500	750	1 500	2 250	3 000	3 750	4 500
<b>30</b>	75	180	255	300	600	900	1 800	2 700	3 600	4 500	5 400
<b>45</b>	112,5	270	382,5	450	900	1 350	2 700	4 050	5 400	6 750	8 100
<b>60</b>	150	360	510	600	1 200	1 800	3 600	5 400	7 200	9 000	10 800
<b>90</b>	225	540	765	900	1 800	2 700	5 400	8 100	10 800	13 500	16 200

# 7. Shutdown

## 7.1 Temporary shutdown

You can temporarily shut down the described product by disconnecting the electrical, pneumatic, and/or hydraulic supply connections. For more information, see the section *General information* in this manual.

If you wish to shut down the product temporarily, refer also to the instructions in the section *Transport, delivery, and storage* of this manual.

When placing the product back into operation, refer to the information in the sections *Installation* and *Commissioning* of this manual.

## 7.2 Permanent shutdown

All country specific legal guidelines and legislation on the disposal of contaminated equipment must be observed when shutting down the product for the final time.



### Caution!

Lubricants can contaminate the ground and watercourses. Lubricants must be used and disposed of in compliance with the rules. Instructions and local regulations must be observed when handling lubricants.

The system can also be taken back by SKF for disposal if the costs are covered.

## 8. Maintenance



### CAUTION!

Working on products that have not been disconnected from the power supply can cause serious injury or death to persons. Installation, maintenance, and repair work may only be carried out by qualified experts on a product that is not connected to a power supply. The supply voltage must be turned off before any product components are opened.



### CAUTION!

The lubrication system may be under pressure. Centralized lubrication systems must therefore be depressurized before starting installation, maintenance, or repair work and before making any changes to the system.



### CAUTION!

The described product may be under pressure when it is being operated. The product must therefore be depressurized before starting installation, maintenance, or repair work and before making any changes to the system.

The VTEC units are for the most part maintenance free. To ensure they work properly, however, please regularly check the following:

- Regularly check the level of lubricant in the reservoir and, if necessary, replace or refill the reservoir.
- Check the system regularly for external damages and leaks.
- All electrical connections and lines must be checked regularly for damage and to ensure that they are firmly in place.
- Any faults found must be properly rectified before the system is activated again.



You must not dismantle the product or parts of the product during the warranty period. Doing so invalidates all warranty claims.

Only original SKF spare parts may be used. It is prohibited for the operator to make alterations to the product or to use non original spare parts and resources. Doing so invalidates all warranty claims.

SKF is not liable for damage caused by improper installation, maintenance, or repair work.

## 9. Failures

Table 5 gives an overview of possible malfunctions and their causes. If you are unable to rectify the malfunction, please contact SKF Service Center.

 You must not dismantle the product or parts of the product during the warranty period. Doing so invalidates all warranty claims.

 All other work relating to installation, maintenance, and repair must only be carried out by SKF Service.

 Only original SKF spare parts may be used. It is prohibited for the operator to make alterations to the product or to use non original spare parts and resources.



### **CAUTION!**

Working on products that have not been disconnected from the power supply can cause serious injury or death to persons. Installation, maintenance, and repair work may only be carried out by qualified experts on products that are not connected to a power supply. The supply voltage must be turned off before any product components are opened.



### **CAUTION!**

Centralized lubrication systems are under pressure when they are being operated. Centralized lubrication systems must therefore be depressurized before starting installation, maintenance, or repair work and before making any changes to the system.

Table 5

## Failure analysis and remedy

Problem	Cause	Remedy
<b>No lubricant exits the nozzle</b>	No lubricant exits the nozzle	Check the lubricant level in the reservoir and fill it if necessary Check the tightness of the line reservoir/VTEC unit (connectors and hoses). If necessary change the faulty part.
	Unsuitable lubricant	Empty the entire centralized lubrication system of unsuitable lubricant and fill it with new lubricant. The old lubricant must be properly disposed of.
	The micropump does not deliver	See fault "pump does not work"
	Faulty line outlet/nozzle	Check the tightness of the connectors and the coaxial line. If necessary change the faulty part.
	Reservoir stop cock closed	Open the stop cock
<b>No air at the nozzle outlet</b>	Problem of general air supply	Check the tightness of the line air supply line/VTEC unit (connectors and hose). If necessary change the faulty part. Check if the air supply line is correctly connected to the VE1B air inlet port.
	The general air solenoid valve does not work or is shut off.	Check the electric connection of the solenoid valve  Check the good function of the solenoid valve with the manual control
	Faulty carrier air pressure regulator or set to 0	Check the good function and the setting of the carrier air flow regulator
	Faulty line outlet/nozzle	Check the tightness of the connectors and the coaxial line. If necessary change the faulty part. Check if the coaxial line is not bent

## Failure analysis and remedy

Problem	Cause	Remedy
<b>Micropump does not work</b>	Wrong setting of the metered volume	Check the setting of the metered volume of the micropump
	No air supply to the micropump	Check the good function of the general air solenoid valve or of the air solenoid valve of the micropump <ul style="list-style-type: none"> <li>• Check the electric connection of the solenoid valve</li> <li>• Check the good function of the solenoid valve with the manual control</li> </ul>
	The pulse generator is faulty or not correctly set	Check the good function and the setting of the pulse generator
	Air in the micropump	Adjust the flow rate of the micropump to the maximal and actuate the micropump till lubricant without air comes out.
<b>Air noise</b>	The air line is leaking	Check the pressurized air supply line. If the line is faulty change it. Check the outer tube of the coaxial line. If the tube is faulty change the coaxial line.

# 10. Technical data

Table 6

## Technical data

VTEC system

### VTEC unit

Number of outlets	1 to 8
Min. air inlet	800 Nl/min, dry and filtered air (5 µm)
Air inlet pressure	5 to 8 bar
Micropump flow rate	3, 5, 10, 15, 20 and 30 mm <sup>3</sup> /stroke (small flow, metering rings) 7 to 30 mm <sup>3</sup> / stroke (small flow, thumb wheel) 30, 45, 60, and 90 mm <sup>3</sup> /stroke (large flow, metering rings) 30 to 90 mm <sup>3</sup> / stroke (large flow, thumb wheel)
Max. pump working frequency	3 strokes/s
Lubricant	mineral or synthetic oils, biodegradable oils
Eff. viscosity (at operating temperature)	10 to 400 mm <sup>2</sup> /s
Operating temperature	10 to 50 °C
Audible emissions	Cat. A (≤ 70 dB)
Fixing rail	EN 50035 or EN 50022
<b>General air solenoid valve</b>	
Delivery rate (at 6 bar)	1,100 Nl/min
Power supply	115 V – 50/60 Hz – 2,1 VA or 230 V – 50/60 Hz – 2,1 VA or 24 V – 1,8 W
Protection	IP 65
Mechanical life	1,5 × 10 <sup>7</sup> switching operations



**Technical data**

VTEC system

**Air solenoid valve (micropump control)**

Delivery rate (at 6 bar)	150 NI/min
Power supply	115 V – 50/60 Hz – 2,5 VA or 230 V – 50/60 Hz – 2,5 VA or 24 V – 1 W
Protection	IP 65
Mechanical life	$1,5 \times 10^7$ switching operations

**pneumatic pulse generator**

Delivery rate (at 6 bar)	170 NI/min
Mechanical life	$1 \times 10^7$ switching operations
Frequency	0.04 to 3 Hz

**Pressure switch**

Switching capacity	100 VA
Protection	IP65
Voltage max.	42 V
Mechanical life	$1 \times 10^6$ switching operations

**Lubricant flow sensor GS304P**

Suitable for metered quantities from	10 to 600 mm <sup>3</sup>
Max. Working frequency	4 pulses/min
Lubricant viscosity	10 to 400 mm <sup>2</sup> /s
Rated voltage	24 V DC
Load current I <sub>A</sub>	500 mA maxi per outlet

# 11. Spare parts and accessories



Only original SKF spare parts may be used. It is prohibited for the operator to make alterations to the product or to use non original spare parts and resources.

Table 7

## List of spare parts

Order No.	Designation
<b>PV.1975.0.30</b>	Set of metering rings for micropump (0 to 30 mm <sup>3</sup> )
<b>PV.2063.0.90</b>	Set of metering rings for micropump (0 to 90 mm <sup>3</sup> )
<b>PV-2126</b>	Set of seals (tightness between the micropump and the base plate)
<b>AC.2040.X5B</b>	Pressure switch (NO), set at 5 bar (base plate 'I')
<b>AC.2040.W03B</b>	Pressure switch (NO), set at 0,3 bar
<b>AC.2187.1</b>	Cover for pressure switch
<b>SY.9243.N</b>	Pneumatic pulse generator
<b>AC-4680+---</b>	Solenoid valve 3/2 NC (air for the actuation of the micropump)
<b>MOD-1001</b>	Carrier air flow regulator
<b>MOD-1004</b>	Manometer 0 to 4 bar
<b>MOD-1005</b>	Manometer 0 to 10 bar (for base I)
<b>MOD-100</b>	Set of fixing elements + seals + seals (for one module) to mount the bases together (tight)
<b>MOD-101</b>	Flow sensor kit + seals
<b>MOD-1006-1+---</b>	General air solenoid valve
<b>PV-003-MOD</b>	Micropump, max. flow rate 30 mm <sup>3</sup> /stroke, adjustment with rings
<b>PVR-003-MOD</b>	Micropump, max. flow rate 30 mm <sup>3</sup> /stroke, adjustment thumb wheel
<b>PVI-003-MOD</b>	Micropump, max. flow rate 30 mm <sup>3</sup> /stroke, adjustment with rings, stainless steel
<b>PVRI-003-MOD</b>	Micropump, max. flow rate 30 mm <sup>3</sup> /stroke, adjustment thumb wheel, stainless steel
<b>PV-005-MOD</b>	Micropump, max. flow rate 90 mm <sup>3</sup> /stroke, adjustment with rings
<b>PVR-005-MOD</b>	Micropump, max. flow rate 90 mm <sup>3</sup> /stroke, adjustment thumb wheel
<b>PVI-005-MOD</b>	Micropump, max. flow rate 90 mm <sup>3</sup> /stroke, adjustment with rings, stainless steel
<b>PVRI-005-MOD</b>	Micropump, max. flow rate 90 mm <sup>3</sup> /stroke, adjustment thumb wheel, stainless steel



## SKF France

Lubrication Product Division

Bld Charles de Gaulle, B.P. 239

37540 St-Cyr-sur-Loire – FRANCE

Tel. +33 (0) 247 405 300 Fax +33 (0) 247 405 353

lubrication-france@skf.com

### **!** Important information on product usage

SKF and Lincoln lubrication systems or their components are not approved for use with gases, liquefied gases, pressurized gases in solution and fluids with a vapor pressure exceeding normal atmospheric pressure (1 013 mbar) by more than 0,5 bar at their maximum permissible temperature.

© SKF is a registered trademark of the SKF Group.

© SKF Group 2018

The contents of this publication are the copyright of the publisher and may not be reproduced (even extracts) unless prior written permission is granted. Every care has been taken to ensure the accuracy of the information contained in this publication but no liability can be accepted for any loss or damage whether direct, indirect or consequential arising out of the use of the information contained herein.

PUB 951-130-440/3 EN • March 2018

